



# SC15 PRISMA SYSTEM CONTROL CENTER

User Guide



## CAUTION

TO REDUCE THE RISK OF FIRE, REPLACE WITH THE SAME TYPE AND RATING OF FUSE.

## ATTENTION

UTILISER UN FUSIBLE DE RECHANGE MÊME TYPE.

## Safety compliance

This product has been designed to meet the IEC 60065 international electrical safety standard.

## CAUTION

RISK OF ELECTRIC SHOCK DO NOT OPEN

## ATTENTION

RISQUE DE CHOC ELECTRIQUE NE PAS OUVRIR



The lightning flash with an arrowhead symbol within an equilateral triangle, is intended to alert the user to the presence of uninsulated 'dangerous voltage' within the product's enclosure that may be of sufficient magnitude to constitute a risk of electric shock to persons.



The exclamation point within an equilateral triangle is intended to alert the user to the presence of important operating and maintenance (servicing) instructions in the literature accompanying the product.

**CAUTION:** To reduce the risk of electrical shock do not remove cover (or back). No user serviceable parts inside. Refer servicing to qualified service personnel.

**WARNING:** To reduce the risk of fire or electrical shock, do not expose this apparatus to rain or moisture.

**CAUTION:** In Canada and the USA, to prevent electric shock, match the wide blade of the plug to the wide slot in the socket and insert the plug fully into the socket.

This product is designed and manufactured to meet strict quality and safety standards. However, you should be aware of the following installation and operation precautions.

### 1. Take heed of warnings & instructions

You should read all the safety and operating instructions before operating this appliance. Retain this handbook for future reference and adhere to all warnings in the handbook or on the appliance.

### 2. Water and moisture

The presence of electricity near water can be dangerous.

Do not use the appliance near water – for example next to a bathtub, washbowl, kitchen sink, in a wet basement or near a swimming pool, etc.

### 3. Object or liquid entry

Take care that objects do not fall and liquids are not spilled into the enclosure through any openings. Liquid-filled objects such as vases should not be placed on the equipment.

### 4. Ventilation

Do not place the equipment on a bed, sofa, rug or similar soft surface, or in an enclosed bookcase or cabinet, since ventilation may be impeded. We recommend a minimum distance of 50mm around the sides and top of the appliance to provide adequate ventilation.

### 5. Heat

Locate the appliance away from naked flames or heat producing equipment such as radiators, stoves or other appliances (including other amplifiers) that produce heat.

### 6. Climate

The appliance has been designed for use in moderate climates.

### 7. Racks and stands

Only use a rack or stand that is recommended for use with audio equipment. If the equipment is on a portable rack it should be moved with great care, to avoid overturning the combination.

### 8. Cleaning

Unplug the unit from the mains supply before cleaning.

The case should normally only require a wipe with a soft, damp, lint-free cloth. Do not use paint thinners or other chemical solvents for cleaning.

We do not advise the use of furniture cleaning sprays or polishes as they can cause indelible white marks if the unit is subsequently wiped with a damp cloth.

### 9. Power sources

This appliance must be connected to a mains socket outlet using the supplied power cord. To disconnect this apparatus from power, you must disconnect the power cord. Make sure the power cord is always easily accessible.

Only connect the appliance to a power supply of the type

described in the operating instructions or as marked on the appliance.

This is a Class 1 device and **must** be earthed.

The power switch is a single-pole switch. When the switch is in the "Off" position, the appliance is not completely disconnected from the main power.

### 10. Power-cord protection

Power supply cords should be routed so that they are not likely to be walked on or pinched by items placed upon or against them, paying particular attention to cords and plugs, and the point where they exit from the appliance.

### 11. Grounding

Ensure that the grounding means of the appliance is not defeated.

### 12. Power lines

Locate any outdoor antenna/aerial away from power lines.

### 13. Non-use periods

If the unit has a stand-by function, a small amount of current will continue to flow into the equipment in this mode. Unplug the power cord of the appliance from the outlet if left unused for a long period of time.

### 14. Abnormal smell

If an abnormal smell or smoke is detected from the appliance, turn the power off immediately and unplug the unit from the wall outlet. Contact your dealer immediately.

### 15. Servicing

You should not attempt to service the appliance beyond that described in this handbook. All other servicing should be referred to qualified service personnel.

### 16. Damage requiring service

The appliance should be serviced by qualified service personnel when:

- the power-supply cord or the plug has been damaged, or
- objects have fallen, or liquid has spilled into the appliance, or
- the appliance has been exposed to rain, or
- the appliance does not appear to operate normally or exhibits a marked change in performance, or
- the appliance has been dropped or the enclosure damaged.

## 2.4G and 5G FCC Statements

This device complies with Part 15 of the FCC Rules. Operation is subject to the following two conditions:

1. This device may not cause harmful interference, and
2. This device must accept any interference received, including interference that may cause undesired operation.

Cet appareil est conforme à la section 15 des réglementations de la FCC. Le fonctionnement de l'appareil est sujet aux deux conditions suivantes :

1. cet appareil ne doit pas provoquer d'interférences néfastes, et
2. cet appareil doit tolérer les interférences reçues, y compris celles qui risquent de provoquer un fonctionnement indésirable.

**Note:** This product has been tested and found to comply with the limits for a Class B digital device, pursuant to Part 15 of the FCC Rules. These limits are designed to provide reasonable protection against harmful interference in a residential installation. This product generates, uses, and can radiate radio frequency energy and, if not installed and used in accordance with the instructions, may cause harmful interference to radio communications. However, there is no guarantee that interference will not occur in a particular installation. If this product does cause harmful interference to radio or television reception, which can be determined by turning the equipment off and on, the user is encouraged to try to correct the interference by one or more of the following measures:

- Reorient or relocate the receiving antenna.
- Increase the separation between the equipment and receiver.
- Connect the equipment into an outlet on a circuit different from that to which the receiver is connected.
- Consult the dealer or an experienced radio/TV technician for help.

Please take attention that changes or modification not expressly approved by the party responsible for compliance could void the user's authority to operate the equipment.

This equipment should be installed and operated with a minimum distance 20cm between the radiator and your body .

Cet équipement doit être installé et utilisé à une distance minimale de 20 cm entre le radiateur et votre corps.

This device complies with Industry Canada licence-exempt RSS standard(s). Operation is subject to the following two conditions:

1. this device may not cause interference, and
2. this device must accept any interference, including interference that may cause undesired operation of the device.

Le présent appareil est conforme aux CNR d'Industrie Canada applicables aux appareils radioexempt de licence. L'exploitation est autorisée aux deux conditions suivantes :

1. l'appareil ne doit pas produire de brouillage, et
2. l'utilisateur de l'appareil doit accepter tout brouillage radioélectrique subi, même si le brouillage est susceptible d'en compromettre le fonctionnement.

Under Industry Canada regulations, this radio transmitter may only operate using an antenna of a type and maximum (or lesser) gain approved for the transmitter by Industry Canada. To reduce potential radio interference to other users, the antenna type and its gain should be so chosen that the equivalent isotropically radiated power (e.i.r.p.) is not more than that necessary for successful communication.

Conformément à la réglementation d'Industrie Canada, le présent émetteur radio peut fonctionner avec une antenne d'un type et d'un gain maximal (ou inférieur) approuvé pour l'émetteur par Industrie Canada. Dans le but de réduire les risques de brouillage radioélectrique à l'intention des autres utilisateurs, il faut choisir le type d'antenne et son gain de sorte que la puissance isotrope rayonnée équivalente (p.i.r.e.) ne dépasse pas l'intensité nécessaire à l'établissement d'une communication satisfaisante.



The CE symbol indicates that this Primare product complies with the EMC (Electromagnetic Compatibility) and LVD (Low Voltage Directive) standards of the European Community.

The WEEE symbol indicates this Primare product complies with the European Parliament and Council Directive 2002/96/EC concerning Waste Electrical and Electronic Equipment (WEEE). This product must be appropriately recycled or processed in accordance with these directives. Consult your local waste disposal authority for guidance.

The RoHS symbol indicates that Primare products are designed and manufactured to comply with the Restriction of Hazardous Substances (RoHS) as stated in the European Parliament and Council Directive 2002/95/EC.

### Copyright and acknowledgments

Copyright © 2017-18 Primare AB.  
All rights reserved.

Primare AB  
Limstensgatan 7  
21616 Limhamn  
Sweden

<http://www.primare.net>

Issue: SC15Prisma/2

The information in this guide is believed to be correct as of the date of publication. However, our policy is one of continuous development and so the information is subject to change without notice, and does not represent a commitment on the part of Primare AB.

Primare is a trademark of Primare AB.

This guide was produced by  
Human-Computer Interface Ltd.  
<http://www.interface.co.uk>



# CONTENTS

## Welcome!

### Getting Started

- 1 Unpack the SC15
- 2 Connect outputs
- 3 Connect inputs
- 4 Connect the antennae
- 5 Connect power
- 6 Connect to a network

### Back-panel connections

### Using the remote control

- Selecting SC15 mode
- Fitting the batteries

### Using the SC15

- Front panel controls
- Changing the volume
- Selecting a source
- Changing the display brightness

### Connecting direct sources

### Playing music from a drive or music server

### Streaming music from a phone, tablet, or PC

6	<b>Configuring the settings</b>	15
	Using the settings menus	15
7	INPUT SETTINGS	15
7	AUDIO SETTINGS	16
7	GENERAL SETTINGS	16
7	STREAMING SETTINGS	17
8	NETWORK SETTINGS	17
8	<b>Technical specification</b>	18
	Analogue inputs	18
9	Analogue outputs	18
10	Digital inputs	18
10	Digital outputs	18
10	Performance	18
	Network	18
11	General	18
11	<b>Additional information</b>	19
11	Phase	19
11	Burn-in	19
	RS232 and trigger	19
12	Using the SC15 with a DD15	19
13	Factory reset	19
	Network troubleshooting	19
14	Spotify Connect	19
	<b>Index</b>	21

# WELCOME!

## **Congratulations on selecting your new SC15 Prisma System Control Center**

This user guide describes the features and explains how to set up the control center for the best sound quality and ease of operation in order to allow for the most enjoyable reproduction of sound from all your sources.

For additional support and assistance please contact your local authorized Primare dealer, or visit our website at [www.primare.net](http://www.primare.net).



# GETTING STARTED

## 1 Unpack the SC15

Your SC15 is supplied with:

- This User Guide
- The Chromecast built-in Quick Start Guide
- Mains cable
- IR cable
- Trigger cable
- Antennas for Bluetooth and Wi-Fi
- C25 remote control with batteries
- AC Polarity Pen

If any of these items are missing please contact your supplier. We recommend you retain the packaging in case you need to transport the unit at a later date.

Note that the SC15 is supplied with a protective film on the display glass. Remove the film for a clearer whiter display.

## 2 Connect outputs

### Analogue outputs

The SC15 provides a fixed-level or variable-level analogue output on the ANALOG OUT output on RCA connectors, to allow you to connect to active speakers or an analogue recorder.

### Digital output

The SC15 also provides a coax digital output on an RCA connector.

## 3 Connect inputs

You can connect up to two analogue sources and up to four digital sources to the inputs on the back panel.

### Analogue sources

- Connect an analogue source to A1, using a high quality RCA cable.
- A second analogue source can be connected to D6, using a cable terminated in a 3.5mm jack plug.

### Digital sources

- Connect digital optical sources to the digital optical inputs D2 to D4 using optical cables. D6 can be used for an additional optical source.
- Connect a digital coax source to D5, using a digital RCA cable.

You can also connect a USB flash drive to the USB-A input, and a PC or Mac to the USB-B input to use the SC15 as an audio output device for your computer. For more information see *PLAYING MUSIC FROM A DRIVE OR MUSIC SERVER*, page 13.

### Streaming

You can stream music wirelessly to the SC15 from a mobile phone, tablet, computer, or other Prisma product via Bluetooth or Wi-Fi, or via a wired Ethernet connection. For more information see *STREAMING MUSIC FROM A PHONE, TABLET, OR PC*, page 14.

## 4 Connect the antennae

- Connect the two antennae supplied with the SC15 to the ANT 1 and ANT 2 sockets on the back panel, and position the two antennae at a slight angle from the vertical.

One antenna is for Bluetooth connectivity, and the other one is for Wi-Fi connectivity.

## 5 Connect power

- Plug one end of the mains cable supplied with the SC15 into the power connector on the back panel, and connect the other end to a wall socket.

If this cable is not suitable for your power outlets please contact your supplier for an alternative cable.

**Note:** See *Phase*, page 19, for information about getting the best sound from your SC15.



**WARNING:** Always disconnect the SC15 from the mains power before connecting or disconnecting any cables.

- Switch on the SC15, using the switch on the back panel.

### To switch on from standby

- Press  on the front panel or remote control.

The display shows:



PRIMARE

## 6 Connect to a network

The first time you start up the SC15 you will be prompted to specify how you want to connect to the network:

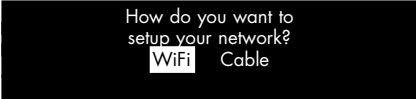

How do you want to  
setup your network?  
WiFi Cable

For best results we recommend connecting via cable.

### Connecting via an Ethernet cable

To connect via an Ethernet cable select **Cable**.

When the SC15 is ready to set up the network the display will show:

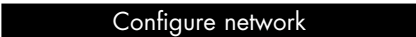

Configure network

- Connect an Ethernet cable between your router and the LAN socket on the back panel of the SC15.
- Install the free **Google Home** app on your mobile device.
- Run **Google Home**.

It will display **New device found, SC15**.

- Click **SET UP** and follow the instructions.

After playing a test sound you will be prompted to select a name for your SC15.

You will now be able to stream music to your SC15.

### Connecting via Wi-Fi

To connect via Wi-Fi select **WiFi**.

When the SC15 is ready to set up the network the display will show:



Setup mode

- Make sure Bluetooth and Wi-Fi are enabled on your mobile device.
- Install the free **Google Home** app on your mobile device.
- Run **Google Home**.

It will display **New device found, SC15**.

- Click **SET UP** and follow the instructions.

After playing a test sound you will be prompted to connect to your home Wi-Fi network.

- Select your Wi-Fi network and enter the password.

You will now be able to stream music to your SC15.



# BACK-PANEL CONNECTIONS

The following diagram explains the function of each of the connectors on the back panel:

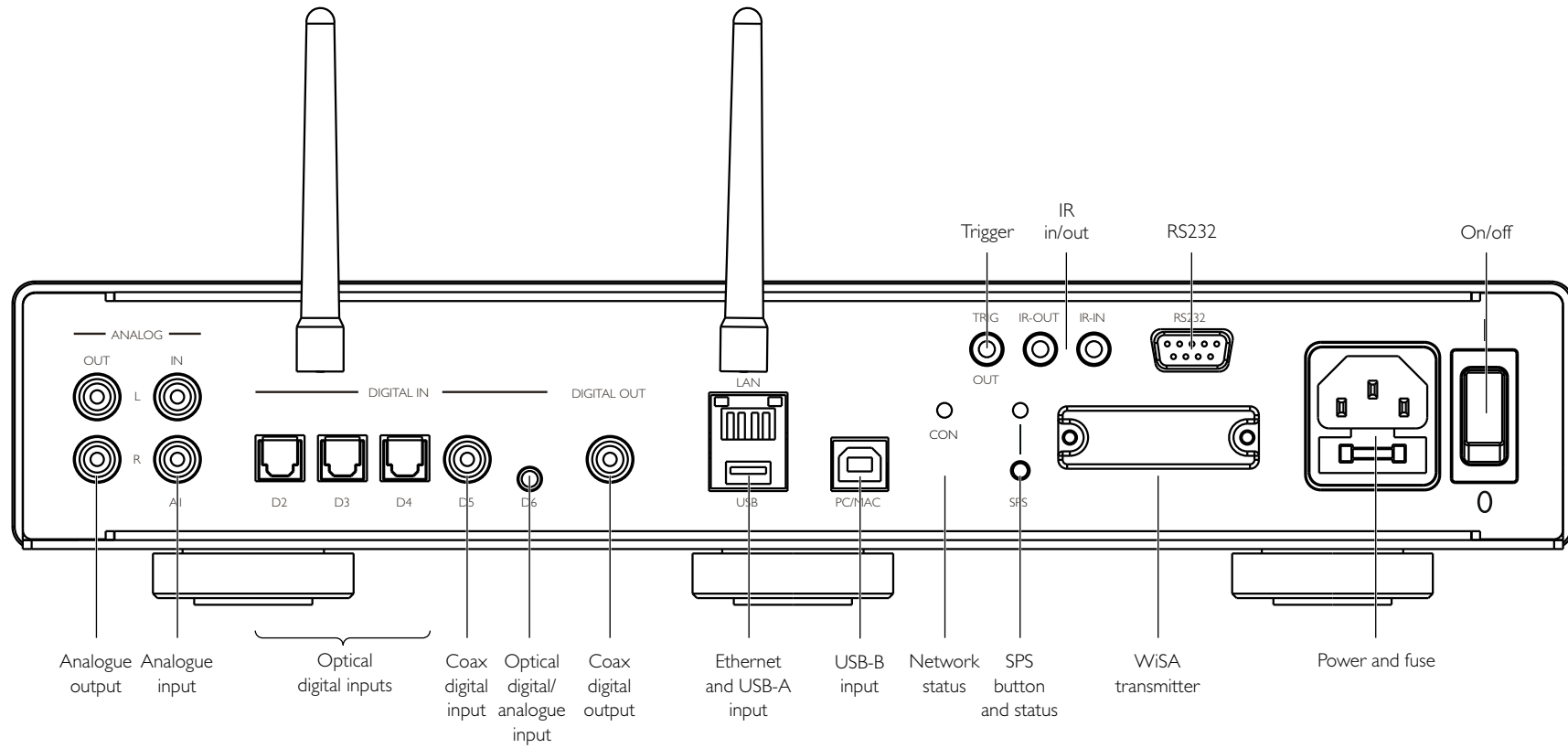

# USING THE REMOTE CONTROL

## Selecting SC15 mode

The remote control can operate any associated Primare products you have in your system.

### To make the remote control operate the SC15

- Press the **CD SC** button twice.

### To make the remote control operate another product

- Press the **AMP AV**, **CD SC**, or **PRE AUX** button as appropriate.

Press once to select the product on the top line of the button, or twice to select the product on the second line.

The indicators at the top of the remote control light when pressing a button to show which mode the remote control is in.

## Fitting the batteries

Before using the remote control you need to insert the two AAA cells supplied with the C25.

- Open the cover on the back of the remote control by pressing the back cover gently near the centre of the remote control, and sliding it towards the edge of the remote control.
- Insert the two batteries, with the polarity as indicated on the bottom of the battery compartment.
- Replace the cover and push until it clips into place.



**Note:** Replace only with 1.5V alkaline cells type AAA or equivalent.

When disposing of old batteries please be considerate to the environment.

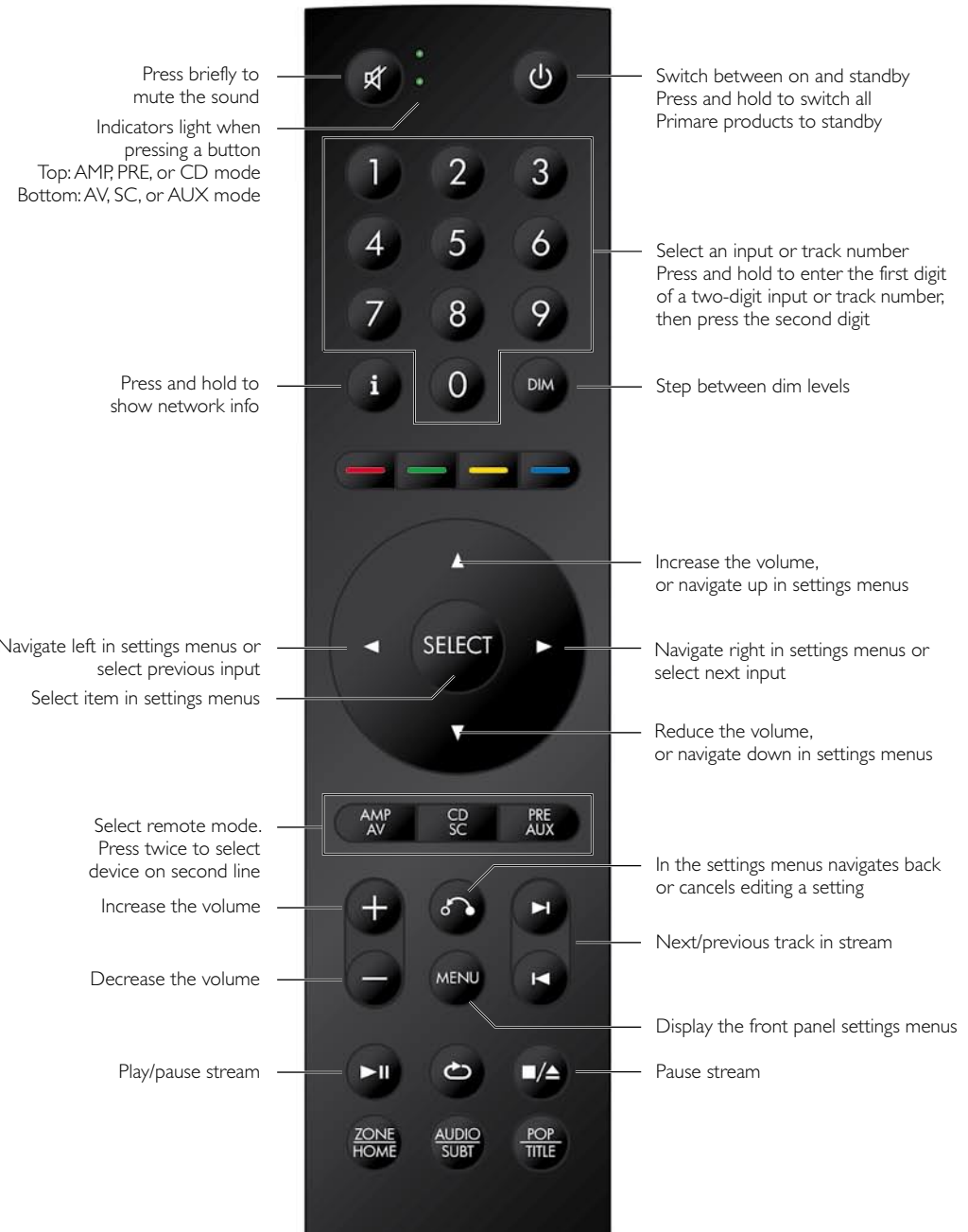

# USING THE SC15

## Front panel controls

### Standby

Switches the SC15 to standby, or switches it on from standby.

### SELECTOR

Steps between inputs.

### ▲ and ▼

Change the volume.

### Settings menus

Pressing ▲ and ▼ simultaneously displays the settings menus or exits from the menus.

In the settings menus:

Pressing ▲ or ▼ steps between the settings.

Pressing **SELECTOR** selects a setting or saves an edited setting.

Holding down **SELECTOR** navigates back or cancels editing a setting.

## Changing the volume

The SC15 allows you to vary the volume from 0 (silence) to 99 (maximum).

### To change the volume

- Press the ▲ or ▼ buttons on the front panel, or press the + or – buttons or the ▲ or ▼ buttons on the remote control.

The current volume setting is shown on the front panel; for example:

VOL 28

## Selecting a source

The SC15 provides a choice of seven inputs. Initially these are labelled as shown in the following table, but you can give them your own aliases to suit the sources in your system; see *ALIAS*, page 15.

Label	Description
A1	Analogue on RCA connectors.
D2–D4	Digital optical on TOS connectors.
D5	Digital coax on RCA connectors.
D6	Digital optical or analogue on a 3.5mm jack.
PC/MAC	Digital on a USB-B connector.

### To select a source

- Press the **SELECTOR** button on the front panel until the source is indicated on the front panel display; for example:

A1

- Alternatively, press the ◀ or ▶ buttons on the remote control to step between sources, or press one of the buttons **1** to **7** on the remote control to select the corresponding source directly.

## Changing the display brightness

### To change the front panel display brightness

- Press the **DIM** button on the remote control to step through the three levels of illumination and blank.

If you turn the display off it will be restored briefly when you operate any control.

The display automatically dims after ten minutes; you can adjust this delay in the settings menus; see *GENERAL SETTINGS*, page 16.

# CONNECTING DIRECT SOURCES

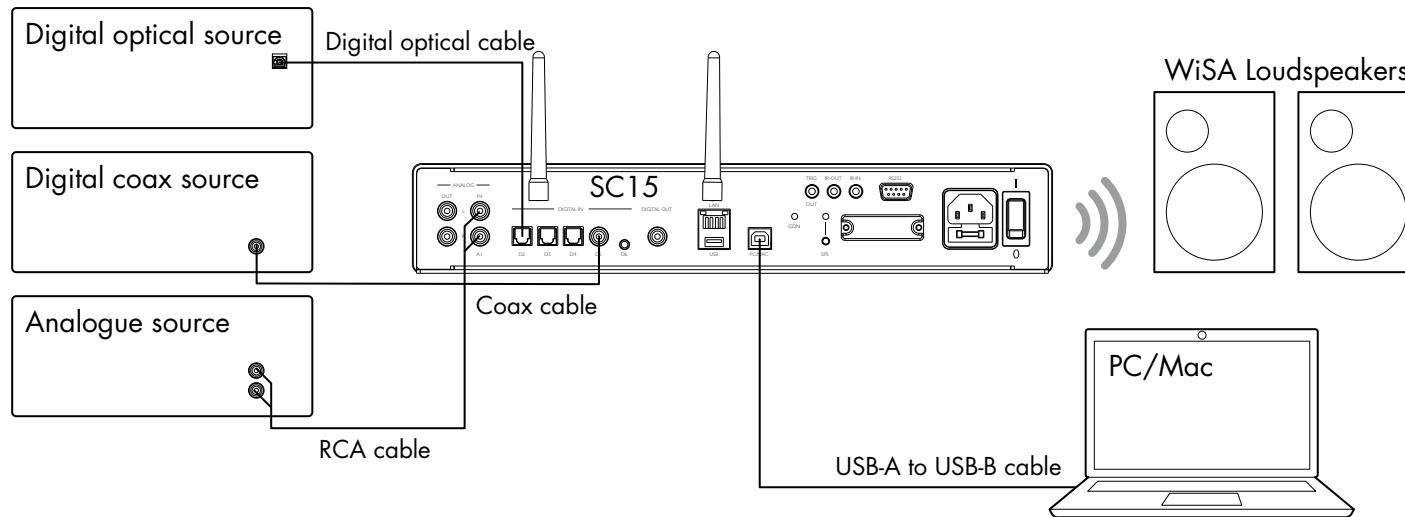

These methods of playing music from the SC15 involve connecting the source to the SC15 via a cable, and don't require Wi-Fi, Ethernet, or Bluetooth.

## To play music from a source

- Connect the source via a suitable cable:

Analogue	Phono RCA cable
Digital optical source	Digital optical cable
Digital source	Digital coax cable

- Select the source from the front panel, or using the remote control.

If you have a phone or tablet on the same Wi-Fi network as the SC15 you can also use the Prisma app to select and control sources.

## To use the SC15 as a PC/Mac sound output device

- Connect the Mac or PC to the SC15 via a USB-A to USB-B cable.

### PC

Windows 7, 8, 8.1, or 10 (32/64-bit) is required. You need to install the Primare xmos audio driver, available on [primare.net](http://primare.net).

### Macintosh

OSX 10.4 or later is recommended. No driver is required.

- Connect the computer's USB port to the USB B input on the SC15 using a USB A to USB B cable.

The SC15 will then appear as a sound output device called **SC15** in the Sound control panel (PC) or Sound system preferences panel (Macintosh).

- Select the PC/MAC source on the SC15.
- Select the SC15 as the sound output device in the Mac Sound system preferences panel or the PC Sound control panel.

# PLAYING MUSIC FROM A DRIVE OR MUSIC SERVER

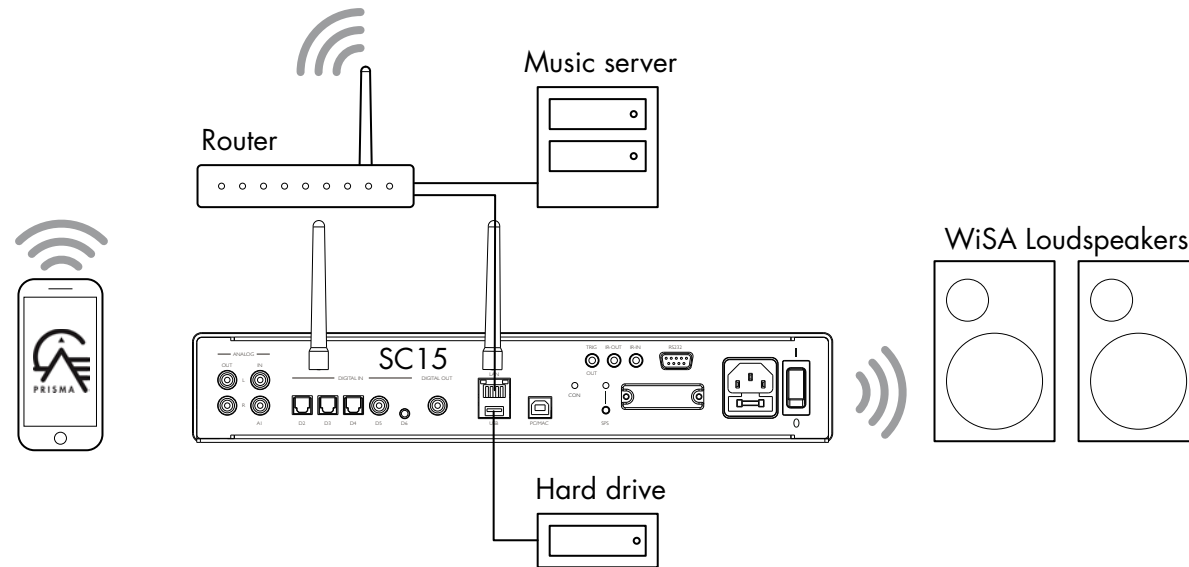

You can play audio files from a USB flash drive, external USB hard disk, or a network drive. These options are ideal if you already have a digital library of CDs or music files.

On a USB flash drive or USB hard disk the files can be organised into folders, giving you one way of classifying your music; eg by Artist.

On a NAS drive you have the option of running a media server program, which will catalogue your music library and give you the option of organising it in different ways; eg by Artist, Genre, Album, or Composer. One free option is MinimServer; see <http://minimserver.com/>.

## To play audio files from a USB flash drive or hard drive

- Connect the USB drive to the USB-A input on the SC15.

The USB drive can contain folders and music files in any of the popular formats; see *TECHNICAL SPECIFICATION*, page 18, for details.

- Use the Prisma app to browse, play, and control the music.

## To play audio files from a NAS (network) drive

- Connect the NAS drive to the same network as the SC15.

The NAS drive can either contain folders and music files in any of the popular formats, or it can run a music server. See *TECHNICAL SPECIFICATION*, page 18, for details of the supported file formats.

- Use the Prisma app to browse, play, and control the music.

Alternatively you can select and play music from a Mac or PC using a music server program such as JRiver or Foobar2000.

# STREAMING MUSIC FROM A PHONE, TABLET, OR PC

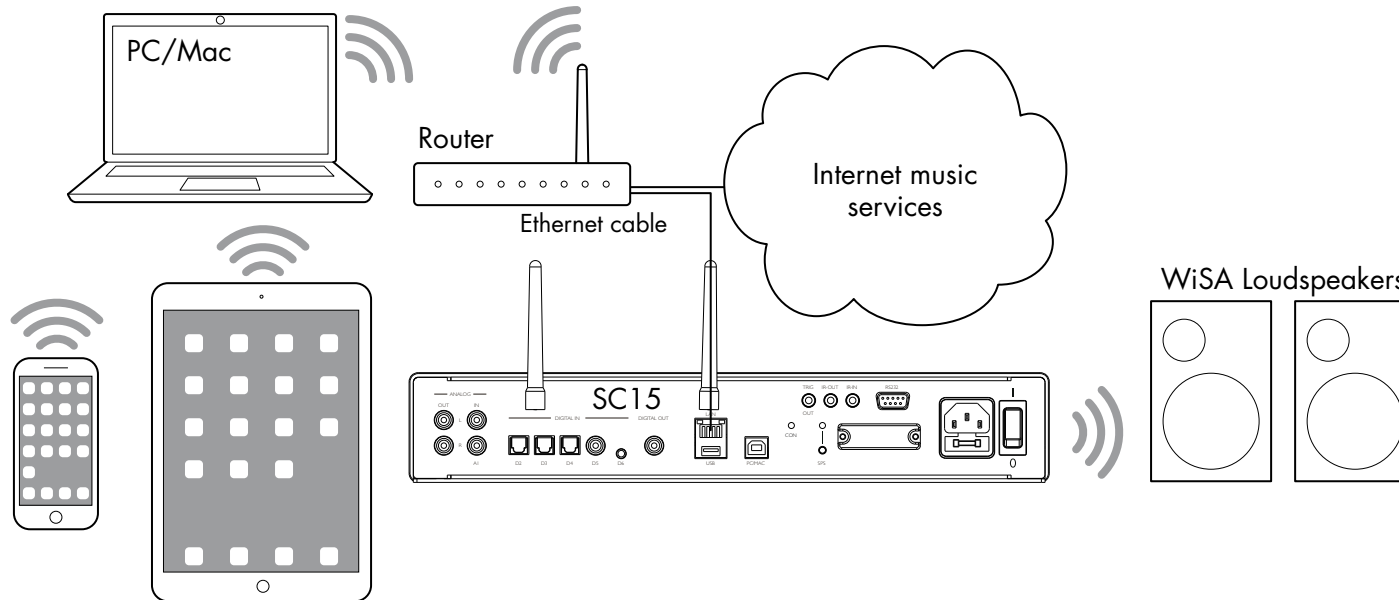

The SC15 can use Chromecast to connect directly to a music service that supports Chromecast, such as Spotify, Deezer, Tidal, or TuneIn Radio. The music is streamed direct to the SC15; once set up you can use your phone to make calls, or play other audio.

With a phone, tablet, or Mac/PC you can also play the audio wirelessly to the SC15, using Bluetooth or AirPlay (iOS only), so the sound from any apps you run on your device will be played through the SC15.

Although you can stream music over Wi-Fi, for best results connect the SC15 to your home router via an Ethernet cable. If necessary, use the Google Home app to configure the network settings on your SC15.

## To stream using Chromecast

The SC15 has Chromecast built-in, which means you can stream (cast) music over your network directly to the SC15 from any Chromecast supported music service, using the music service's app on your desktop or mobile device as a controller.

- Click the Cast button within your music service's app and select the SC15 in the device list.

## To stream using AirPlay

Use AirPlay to send audio over the network from your Apple device to the SC15. AirPlay is only available on Apple devices.

## To stream using Bluetooth

Use Bluetooth to send audio directly to the SC15 from your Bluetooth device using Bluetooth connection. You don't need a network to stream using Bluetooth.

## To stream using Spotify Connect

The SC15 supports Spotify Connect, which means you can stream music directly to the SC15 from the Spotify music service over your network, using the Spotify app on your desktop or mobile device as a controller.

Here are Spotify's instructions:

### Listen out loud with Spotify Connect

1. Connect the SC15 to your wifi network.
2. Open up the Spotify app on your phone, tablet or laptop using the same wifi network.
3. Play a song and select **Devices Available**.
4. Select the SC15 and start listening.

# CONFIGURING THE SETTINGS

## Using the settings menus

You can view and change the SC15 settings from the front panel, remote control, or using the Prisma app.

### To display the settings menu

- Simultaneously press the ▲ or ▼ buttons on the front panel, or press the **MENU** button on the remote control.

The settings menu is displayed:



### To step between settings

- Press the ▲ or ▼ buttons on the front panel or remote control.

The current setting is shown highlighted.

### To change a setting

- Press the **SELECTOR** button on the front panel or the **SELECT** button on the remote control.

The current value is shown highlighted.

- Press the ▲ or ▼ buttons on the front panel, or the ▲ or ▼ or ◀ or ▶ buttons on the remote control, to change the value of the setting.

As you change it the new value is shown in the menu.

- Press the **SELECTOR** button on the front panel or the **SELECT** button on the remote control to save the value you have set.

### To navigate back or cancel editing a setting

- Press and hold the **SELECTOR** button on the front panel, or press the ↶ button on the remote control.

### To exit from the settings menu

- Simultaneously press the ▲ or ▼ buttons on the front panel, or press the **MENU** button on the remote control.

## INPUT SETTINGS

The **INPUT SETTINGS** menu allows you to customise the inputs to suit the sources in your system:



### INPUT

Initially the **INPUT SETTINGS** shows the settings for the currently selected input. Alternatively the **INPUT** option allows you to step between all the inputs. The subsequent options will change according to the input.

### ALIAS

Allows you to give the source a name; eg **RADIO**.

- Highlight the **ALIAS** item then press the **SELECTOR** button on the front panel, or the **SELECT** button on the remote control.

The **RENAME INPUT** menu is displayed:

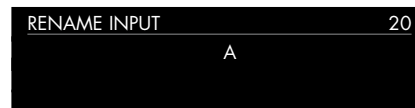

- Press the ▲ or ▼ buttons on the front panel, or the ◀ or ▶ buttons on the remote control, to select the first letter.
- Press the **SELECTOR** button on the front panel or the **SELECT** button on the remote control, to select it.

After adding each character you have the options:

**ADD NEW CHARACTER**  
**CONFIRM 'A'**  
**CLEAR ALIAS**

where **CONFIRM** shows the alias you have entered so far.

- Select **ADD NEW CHARACTER** to add the remaining letters, up to a maximum of six characters.
- Select **CONFIRM** when you have entered the alias you want.

### STATUS

Choose between **ENABLED** (default) or **DISABLED** to specify whether the input is enabled.

### AUTO SENSE

Choose between: **SELECT** to automatically select an input containing an audio signal if the SC15 is on; **WAKE+SELECT** to automatically wake up the SC15 from standby, if necessary, and select an input containing an audio signal; and **OFF** (default) to disable automatic switching.

### VOLUME

Choose between **VARIABLE** (default) or **FIXED** to specify whether the input should have variable or fixed gain.

**FIXED** is 0dB gain, equivalent to volume setting 66, and will overrule **MAXIMUM VOLUME** in **AUDIO SETTINGS**.

Selecting **FIXED** will show a loud-volume warning. Select **YES** to proceed or **NO** to cancel the fixed gain setting.

Fixed gain functions as an SSP (Surround Sound Pass-through) allowing the SC15 to be used as an amplifier in a multi-channel system setup

### INPUT GAIN

Choose between: -30dB to -1dB, 0dB (default), or +1dB to +30dB to set the gain for the selected input.

If the gain is set too high on an input clipping may occur.

## AUDIO SETTINGS

The **AUDIO SETTINGS** menu allows you to customise the balance and start-up volume, and the maximum and mute volume.

AUDIO SETTINGS	20
BALANCE	00LR00
STARTUP VOLUME	30
MAXIMUM VOLUME	99

### BALANCE

Allows you to adjust the balance between 00LR-9 (far left), 00LR00 (centred, default) and -9LR00 (far right).

### STARTUP VOLUME

Sets the general startup volume to between 0 and 60. The default is 20.

### MAXIMUM VOLUME

Set maximum volume limit between 0 and 99. The default is 99.

### MUTE VOLUME

Sets the volume when unit is muted. You can choose between 0 (default) and 30.

If the current volume is lower than the specified **MUTE VOLUME**, the volume will be set to 0 when pressing mute.

## GENERAL SETTINGS

The **GENERAL SETTINGS** menu allows you to configure the general operation of the SC15:

GENERAL SETTINGS	20
FRONT PANEL	UNLOCKED
AUTO-DIM	AFTER 10MIN
STANDBY SETTINGS	

### SHOW INPUTS

Choose between **ALL** (default), to show all inputs, or **WITH SIGNAL**, to show only inputs that have a signal.

### FRONT PANEL

Choose **LOCKED** to lock the front panel buttons, or **UNLOCKED** (default) to use them.

To unlock the front panel buttons use the remote control to select this menu, or remove power from the SC15 for a few seconds.

### AUTO-DIM

Allows you to choose the delay for dimming the display after no user interaction, between: **AFTER 1MIN**, **AFTER 5MIN**, **AFTER 10MIN** (default), or **OFF**.

### STANDBY SETTINGS

Displays the **STANDBY SETTINGS** menu to allow you to specify the standby settings.

**STANDBY MODE** can be set to **ECO** to reduce the standby consumption to less than 0.5W, but only allows the SC15 to wake from the analogue and digital inputs, or **NORMAL** which also allows the SC15 to wake from streaming and the PC/MAC input.

**AUTO-STANDBY** automatically switches the SC15 to standby if there is no user interaction or audio from the current source for a specified delay: **AFTER 10MIN**, **AFTER 15MIN**, **AFTER 20MIN** (default), or **OFF**.

**Note:** The **AUTO-STANDBY** function will be disabled if the network has not been set up.

## FACTORY RESET

Resets the SC15 to the factory default settings.

You are prompted to confirm. Select **YES** to proceed or **NO** to cancel.

## FIRMWARE VERSIONS

Displays the **FIRMWARE VERSIONS** menu to allow you to view the versions of firmware installed.



## STREAMING SETTINGS

Allows you to configure the SC15 streaming:

STREAMING SETTINGS	20
METADATA	ON
BLUETOOTH SETTINGS	
AIRPLAY PASSWORD	

### METADATA

Allows you to choose **ON** (default) or **OFF** to specify whether metadata, such as the artist name and song title, should be displayed.

### BLUETOOTH SETTINGS

Displays the **BLUETOOTH SETTINGS** menu.

**VISIBLE** can be set to **ON** to make the SC15 visible to other Bluetooth devices, or **OFF** (default) to make the SC15 not visible.

**Note:** **VISIBLE** allows any Bluetooth-enabled device within range to discover and pair with your SC15.

**AUTO-CONNECT** can be set to **ON** to automatically reconnect to a paired mobile Bluetooth device when the Bluetooth input on the SC15 is selected, or **OFF** (default) to disable automatic connection.

### AIRPLAY PASSWORD

Allows you to set an optional password for connection by AirPlay. Leave empty for no password.

## NETWORK SETTINGS

Allows you to configure the network connection:

NETWORK SETTINGS	20
QUICK INFO	
NETWORK MODE	WiFi

### QUICK INFO

Shows the **NETWORK INFO** screen with the following information:

- Connection: one of **CONNECTED BY WIFI**, **CONNECTED BY CABLE**, or **NOT CONNECTED**.
- **NETWORK**, the current SSID.
- **IP**, the current IP address.
- **DEVICE NAME**, the device name.
- **WIFI MAC**, the Wi-Fi MAC address.
- **BT MAC**, the current Bluetooth MAC address.

You can also display this information by holding down the **i** button on the remote control.

### NETWORK MODE

Allows you to select between **WiFi** or **Cable** to specify how to connect to the network.

# TECHNICAL SPECIFICATION

## Analogue inputs

- 1 x RCA, 9.5kΩ impedance.
- 1 x 3.5mm stereo jack, 15kΩ impedance.

## Analogue outputs

### Preamplifier output

- 1 x RCA, 150Ω impedance.

## Digital inputs

- 3 x Optical/TOSLINK 192kHz/24bit
- 1 x RCA 192kHz/24bit
- 1x USB-A up to 192kHz/24bit; up to DSD128 (5.6MHz)
- 1x USB-B up to 768kHz/32bit; up to DSD256 (11.2MHz)

## Digital outputs

- 1x RCA
- Analogue input = 48kHz
- Digital input = native output
- 1x Wireless stereo output using WiSA® technology

## Performance

### Gain:

Preamplifier output: 16.5 dB

### Analogue frequency response

20Hz – 20kHz -0.5dB

### Distortion

THD + N: < 0.05%, 20Hz – 20kHz

### Signal to Noise:

Digital: >90 dB

Analogue: >80 dB

## Network

### Connectivity

- 1 x Ethernet LAN port
- 2 x Antennas for Bluetooth and Wi-Fi
- LAN: 10/100Mbit Ethernet port
- WLAN: IEEE 802.11 a/b/g/n/ac compliant; 2.4/5GHz; b, g, n mode

### Audio formats

- WAV, LPCM, AIFF, FLAC, ALAC, WMA, OGG: Up to 192kHz/24bit
- MP3, MP4 (AAC): Up to 48kHz/16bits, VBR & CBR 320kbps
- DSD: Up to DSD128 (5.6MHz)

### Streaming

- Airplay®
- Bluetooth®
- Chromecast built-in®
- Spotify Connect®
- DLNA/UPnP

## General

### Control

- C25 system remote control
- RS232
- IR in/out
- Trigger out

### Power Consumption

- Standby (ECO): <0.5W
- Operate: <12W

### Dimensions

- 350 x 329 x 73 mm (wxdxh) with knobs and connectors
- 350 x 310 x 73 mm (wxdxh) without knobs and connectors

### Weight

6 kg

### Colour

Black or titanium

# ADDITIONAL INFORMATION

These instructions help you get the best possible sound from your SC15.

## Phase

The phase of the AC supply can make a significant difference to the sound.

Use the Polarity Pen supplied with the SC15 to verify which pin is live on your AC power cable.

Ensure that the live pin of the AC power cable is connected to the left-hand pin of the power connector, viewed from the back panel:

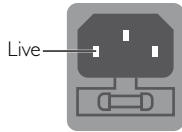

## Burn-in

Your Primare will start to sound best after an initial burn-in of approximately 24 hours.

You will notice a further smaller improvement in sound quality for at least another 3 days' playing.

## RS232 and trigger

The RS232 input allows you to connect the SC15 to a controller system. Use a twisted (null modem) cable. For more information contact Primare at [info@primare.net](mailto:info@primare.net) or visit [www.primare.net](http://www.primare.net).

The Trigger output allows the SC15 to switch on other devices, such as a DD15.

## Using the SC15 with a DD15

Your SC15 is an ideal companion to the Primare DD15 CD Transport. For best results link the two products together as follows using the two cables supplied with the SC15:

### To connect the trigger cable

The Trigger cable ensures that the DD15 switches on, or to standby, when you operate the  $\Phi$  button on the front panel of the SC15.

- Connect the Trigger cable from the SC15 TRIG OUT to the DD15 TRIG IN.

## Factory reset

Press and hold the  $\Phi$  standby button on the front panel to display the main firmware version number.

Press and hold the  $\Phi$  standby button on the front panel for 10 seconds to perform a factory reset of the SC15.

You can also do a factory reset from the Prisma app, or from the **GENERAL SETTINGS** menu; see *GENERAL SETTINGS*, page 16.

## Network troubleshooting

### Front panel display

The front panel display indicates the type of network connection:

**LAN** indicates that you are connected by an Ethernet cable.

**WiFi** indicates that you are connected by wireless.

### Network status

The **CON** indicator on the back panel indicates the network status:

**ON** Indicates the SC15 is connected to a network

**OFF** Indicates no connection to a network

**Flashing** indicates that the network needs to be configured using the Google Home app.

## Spotify Connect

The Spotify Software is subject to third party licenses found here:

[https://beta.developer.spotify.com/private-documentation/esdk-third\\_party\\_licenses](https://beta.developer.spotify.com/private-documentation/esdk-third_party_licenses)



# INDEX

## A

- AirPlay, streaming 14
- AirPlay password (settings menus) 17
- Alias (settings menus) 15
- Analogue inputs and output 9
- Antennae, connecting 8
- Audio settings menu 16
- Auto-dim (settings menus) 16
- Auto sense (settings menus) 15

## B

- Back panel 9
- Balance (settings menus) 16
- Bluetooth, streaming 14
- Bluetooth settings (settings menus) 17

## C

- Chromecast, streaming 14
- Clipping 15
- Coax input 9

## D

- Digital inputs and output 9
- Display brightness, changing 11

## F

- Factory reset 19
- Factory reset (settings menus) 16
- Firmware (settings menus) 16

- Front panel (settings menus) 16

- Front panel controls 11

## G

- General settings menu 16

## H

- Hard disk, playing music from 13

## I

- Input (settings menus) 15
- Input gain (settings menus) 15
- Inputs, connecting 7
- Input settings menu 15
- IR input 9

## M

- Maximum volume (settings menus) 16

### Menus

- Audio settings 16
- General settings 16
- Input settings 15
- Network settings 17
- Streaming settings 17

- Metadata (settings menus) 17

- Mute volume (settings menus) 16

## N

- Network, connecting to 8
- Network drive, playing music from 13
- Network settings menu 17
- Network troubleshooting 19

## O

- Optical inputs 9

## P

- PC/Mac sound output device 12
- Phase 19
- Power, connecting 8

## Q

- Quick info (settings menus) 17

## R

- Remote control 10
  - Fitting batteries 10
- RS232 input 9, 19

## S

- Settings menus 15
- Show inputs (settings menus) 15, 16
- Sources
  - Connecting 12
  - Selecting 11
- Spotify Connect, streaming 14
- Standby settings (settings menus) 16

- Startup volume (settings menus) 16

- Status (settings menus) 15

- Streaming music 7, 14

- Streaming settings menus 17

## T

- Technical specification 18
- Trigger outputs 9

## U

- Unbalanced inputs and output 9
- USB flash drive, playing music from 7

## V

- Volume (settings menus) 15
- Volume, changing 11

## W

- Wi-fi, connecting to 8

# P R I M A R E

THE SOUND AND VISION OF SCANDINAVIA SINCE 1986

LIMSTENSGATAN 7,  
216 16 LIMHAMN, SWEDEN

More information at [primare.net](http://primare.net)

