



I25 DAC INTEGRATED AMPLIFIER

User Guide



CAUTION

TO REDUCE THE RISK OF FIRE, REPLACE WITH THE SAME TYPE AND RATING OF FUSE.

ATTENTION

UTILISER UN FUSIBLE DE RECHANGE MÊME TYPE.

Safety compliance

This product has been designed to meet the IEC 60065 international electrical safety standard.

CAUTION

RISK OF ELECTRIC SHOCK DO NOT OPEN

ATTENTION

RISQUE DE CHOC ELECTRIQUE NE PAS OUVRIR



The lightning flash with an arrowhead symbol within an equilateral triangle, is intended to alert the user to the presence of uninsulated 'dangerous voltage' within the product's enclosure that may be of sufficient magnitude to constitute a risk of electric shock to persons.



The exclamation point within an equilateral triangle is intended to alert the user to the presence of important operating and maintenance (servicing) instructions in the literature accompanying the product.

CAUTION: To reduce the risk of electrical shock do not remove cover (or back). No user serviceable parts inside. Refer servicing to qualified service personnel.

WARNING: To reduce the risk of fire or electrical shock, do not expose this apparatus to rain or moisture.

CAUTION: In Canada and the USA, to prevent electric shock, match the wide blade of the plug to the wide slot in the socket and insert the plug fully into the socket.

This product is designed and manufactured to meet strict quality and safety standards. However, you should be aware of the following installation and operation precautions.

1. Take heed of warnings & instructions

You should read all the safety and operating instructions before operating this appliance. Retain this handbook for future reference and adhere to all warnings in the handbook or on the appliance.

2. Water and moisture

The presence of electricity near water can be dangerous.

Do not use the appliance near water – for example next to a bathtub, washbowl, kitchen sink, in a wet basement or near a swimming pool, etc.

3. Object or liquid entry

Take care that objects do not fall and liquids are not spilled into the enclosure through any openings. Liquid-filled objects such as vases should not be placed on the equipment.

4. Ventilation

Do not place the equipment on a bed, sofa, rug or similar soft surface, or in an enclosed bookcase or cabinet, since ventilation may be impeded. We recommend a minimum distance of 50mm around the sides and top of the appliance to provide adequate ventilation.

5. Heat

Locate the appliance away from naked flames or heat producing equipment such as radiators, stoves or other appliances (including other amplifiers) that produce heat.

6. Climate

The appliance has been designed for use in moderate climates.

7. Racks and stands

Only use a rack or stand that is recommended for use with audio equipment. If the equipment is on a portable rack it should be moved with great care, to avoid overturning the combination.

8. Cleaning

Unplug the unit from the mains supply before cleaning.

The case should normally only require a wipe with a soft, damp, lint-free cloth. Do not use paint thinners or other chemical solvents for cleaning.

We do not advise the use of furniture cleaning sprays or polishes as they can cause indelible white marks if the unit is subsequently wiped with a damp cloth.

9. Power sources

This appliance must be connected to a mains socket outlet using the supplied power cord. To disconnect this apparatus from power, you must disconnect the power cord. Make sure the power cord is always easily accessible.

Only connect the appliance to a power supply of the type

described in the operating instructions or as marked on the appliance.

This is a Class 1 device and **must** be earthed.

The power switch is a single-pole switch. When the switch is in the "Off" position, the appliance is not completely disconnected from the main power.

10. Power-cord protection

Power supply cords should be routed so that they are not likely to be walked on or pinched by items placed upon or against them, paying particular attention to cords and plugs, and the point where they exit from the appliance.

11. Grounding

Ensure that the grounding means of the appliance is not defeated.

12. Power lines

Locate any outdoor antenna/aerial away from power lines.

13. Non-use periods

If the unit has a stand-by function, a small amount of current will continue to flow into the equipment in this mode. Unplug the power cord of the appliance from the outlet if left unused for a long period of time.

14. Abnormal smell

If an abnormal smell or smoke is detected from the appliance, turn the power off immediately and unplug the unit from the wall outlet. Contact your dealer immediately.

15. Servicing

You should not attempt to service the appliance beyond that described in this handbook. All other servicing should be referred to qualified service personnel.

16. Damage requiring service

The appliance should be serviced by qualified service personnel when:

- A. the power-supply cord or the plug has been damaged, or
- B. objects have fallen, or liquid has spilled into the appliance, or
- C. the appliance has been exposed to rain, or
- D. the appliance does not appear to operate normally or exhibits a marked change in performance, or
- E. the appliance has been dropped or the enclosure damaged.

2.4G and 5G FCC Statements

This device complies with Part 15 of the FCC Rules. Operation is subject to the following two conditions:

1. This device may not cause harmful interference, and
2. This device must accept any interference received, including interference that may cause undesired operation.

Cet appareil est conforme à la section 15 des réglementations de la FCC. Le fonctionnement de l'appareil est sujet aux deux conditions suivantes :

1. cet appareil ne doit pas provoquer d'interférences néfastes, et
2. cet appareil doit tolérer les interférences reçues, y compris celles qui risquent de provoquer un fonctionnement indésirable.

Note: This product has been tested and found to comply with the limits for a Class B digital device, pursuant to Part 15 of the FCC Rules. These limits are designed to provide reasonable protection against harmful interference in a residential installation. This product generates, uses, and can radiate radio frequency energy and, if not installed and used in accordance with the instructions, may cause harmful interference to radio communications. However, there is no guarantee that interference will not occur in a particular installation. If this product does cause harmful interference to radio or television reception, which can be determined by turning the equipment off and on, the user is encouraged to try to correct the interference by one or more of the following measures:

- Reorient or relocate the receiving antenna.
- Increase the separation between the equipment and receiver.
- Connect the equipment into an outlet on a circuit different from that to which the receiver is connected.
- Consult the dealer or an experienced radio/TV technician for help.

Please take attention that changes or modification not expressly approved by the party responsible for compliance could void the user's authority to operate the equipment.

This equipment should be installed and operated with a minimum distance 20cm between the radiator and your body.

Cet équipement doit être installé et utilisé à une distance minimale de 20 cm entre le radiateur et votre corps.

This device complies with Industry Canada licence-exempt RSS standard(s). Operation is subject to the following two conditions:

1. this device may not cause interference, and
2. this device must accept any interference, including interference that may cause undesired operation of the device.

Le présent appareil est conforme aux CNR d'Industrie Canada applicables aux appareils radioexempts de licence. L'exploitation est autorisée aux deux conditions suivantes :

1. l'appareil ne doit pas produire de brouillage, et
2. l'utilisateur de l'appareil doit accepter tout brouillage radioélectrique subi, même si le brouillage est susceptible d'en compromettre le fonctionnement.

Under Industry Canada regulations, this radio transmitter may only operate using an antenna of a type and maximum (or lesser) gain approved for the transmitter by Industry Canada. To reduce potential radio interference to other users, the antenna type and its gain should be so chosen that the equivalent isotropically radiated power (e.i.r.p.) is not more than that necessary for successful communication.

Conformément à la réglementation d'Industrie Canada, le présent émetteur radio peut fonctionner avec une antenne d'un type et d'un gain maximal (ou inférieur) approuvé pour l'émetteur par Industrie Canada. Dans le but de réduire les risques de brouillage radioélectrique à l'intention des autres utilisateurs, il faut choisir le type d'antenne et son gain de sorte que la puissance isotrope rayonnée équivalente (p.i.r.e.) ne dépasse pas l'intensité nécessaire à l'établissement d'une communication satisfaisante.



The CE symbol indicates that this Primare product complies with the EMC (Electromagnetic Compatibility) and LVD (Low Voltage Directive) standards of the European Community.

The WEEE symbol indicates this Primare product complies with the European Parliament and Council Directive 2002/96/EC concerning Waste Electrical and Electronic Equipment (WEEE). This product must be appropriately recycled or processed in accordance with these directives. Consult your local waste disposal authority for guidance.

The RoHS symbol indicates that Primare products are designed and manufactured to comply with the Restriction of Hazardous Substances (RoHS) as stated in the European Parliament and Council Directive 2002/95/EC.

Copyright and acknowledgments

Copyright © 2017-18 Primare AB.

All rights reserved.

Primare AB
Limstensgatan 7
21616 Limhamn
Sweden

<http://www.primare.net>

Issue: I25DAC/1

The information in this guide is believed to be correct as of the date of publication. However, our policy is one of continuous development and so the information is subject to change without notice, and does not represent a commitment on the part of Primare AB.

Primare is a trademark of Primare AB.

This guide was produced by
Human-Computer Interface Ltd.
<http://www.interface.co.uk>

CONTENTS

Welcome!

Getting Started

- 1 Unpack the I25
- 2 Connect speakers
- 3 Connect inputs
- 4 Connect power

Back-panel connections

Using the remote control

- Selecting I25 mode
- Fitting the batteries

Using the I25

- Front panel controls
- Changing the volume
- Selecting a source
- Changing the display brightness

Connecting sources

Configuring the settings

- Using the settings menus
- INPUT SETTINGS
- AUDIO SETTINGS
- GENERAL SETTINGS

6	Technical specification	14
7	Speaker outputs	14
7	Analogue inputs	14
7	Analogue outputs	14
7	Digital inputs	14
7	Digital output	14
7	Performance	14
8	General	14
9	Additional information	15
9	Phase	15
9	Burn-in	15
10	RS232 and trigger	15
10	Using the I25 with a DD35	15
10	Error messages	15
10	Factory reset	15
10	Index	17
11		
12		
12		
12		
13		
13		

WELCOME!

Congratulations on selecting your new I25 DAC Integrated Amplifier

This user guide describes the features and explains how to set up the amplifier for the best sound quality and ease of operation in order to allow for the most enjoyable reproduction of sound from all your sources.

For additional support and assistance please contact your local authorized Primare dealer, or visit our website at www.primare.net.



GETTING STARTED

1 Unpack the I25

Your I25 is supplied with:

- This User Guide
- Mains cable
- IR cable
- Trigger cable
- C25 remote control with batteries
- AC Polarity Pen

If any of these items are missing please contact your supplier. We recommend you retain the packaging in case you need to transport the unit at a later date.

Note that the I25 is supplied with a protective film on the display glass. Remove the film for a clearer whiter display.

2 Connect speakers

The I25 is designed to be connected directly to a pair of loudspeakers.

- Connect the red wire from each speaker to the red terminal marked + and the black wire from each speaker to the black terminal marked –.

The terminals can accept speaker cables terminated with spade terminals, banana plugs, or bare wires.

To connect bare wires unscrew the terminal, pass the bare wire through the hole in the terminal bolt, and clamp the wire in place by screwing the terminal back down hand tight.

Analogue outputs

The I25 provides fixed-level and variable-level analogue outputs on the LINE and PRE outputs on RCA connectors, to allow you to connect to active speakers or an analogue recorder.

Digital output

The I25 also provides a coax digital output on an RCA connector.

3 Connect inputs

You can connect up to five analogue sources and up to six digital sources to the inputs on the back panel.

Analogue inputs

- Connect analogue sources, such as the Primare CD35 CD player, to inputs A1 to A5 using high quality RCA cables.

Digital inputs

- Connect digital optical sources to the digital optical inputs D6 to D9 using optical cables.
- Connect digital coax sources to the digital coax inputs D10 and D11 using digital RCA cables.

You can also connect a PC or Mac to the USB-B input to use the I25 as an audio output device for your computer.

4 Connect power

- Plug one end of the mains cable supplied with the I25 into the power connector on the back panel, and connect the other end to a wall socket.

If this cable is not suitable for your power outlets please contact your supplier for an alternative cable.

Note: See *Phase*, page 15, for information about getting the best sound from your I25.



WARNING: Always disconnect the I25 from the mains power before connecting or disconnecting any cables.

- Switch on the I25, using the switch on the back panel.

The standby indicator will light up on the front panel.

To switch on from standby

- Press  on the front panel or remote control.

The display shows:

PRIMARE

BACK-PANEL CONNECTIONS

The following diagram explains the function of each of the connectors on the back panel:

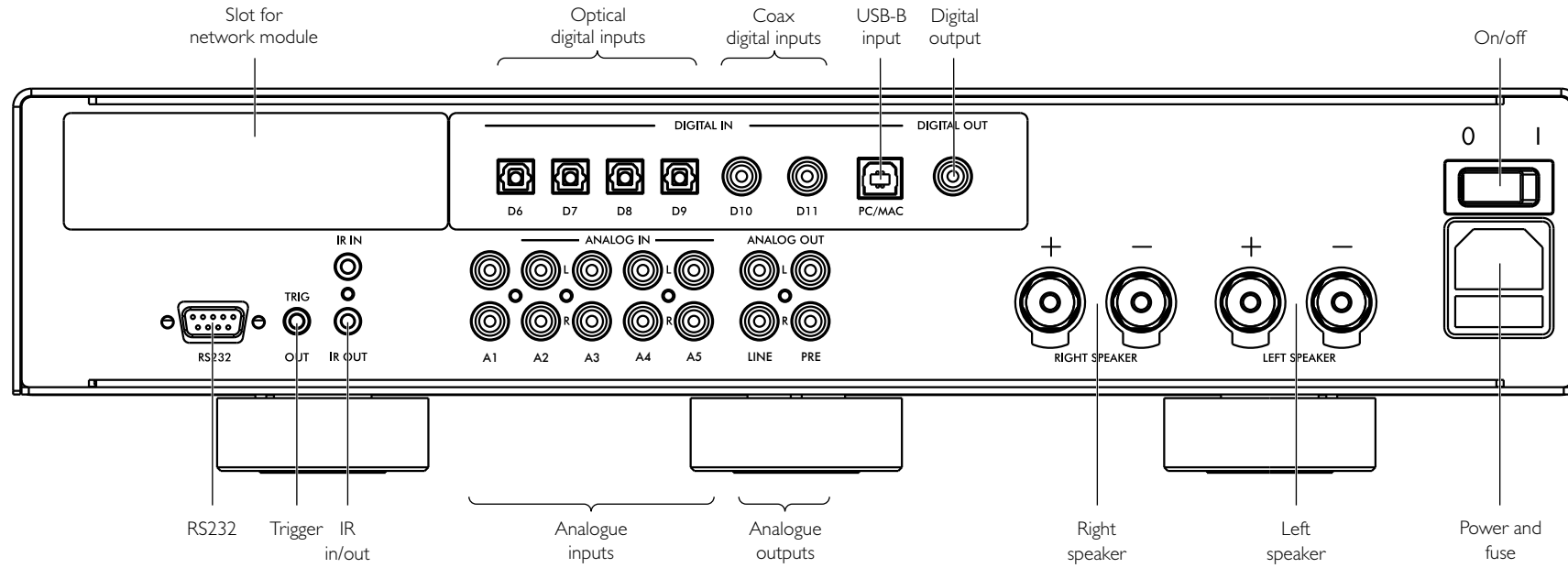

USING THE REMOTE CONTROL

Selecting I25 mode

The remote control can operate any associated Primare products you have in your system.

To make the remote control operate the I25

- Press the **AMP AV** button once.

To make the remote control operate another product

- Press the **AMP AV**, **CD SC**, or **PRE AUX** button as appropriate.

Press once to select the product on the top line of the button, or twice to select the product on the second line.

The indicators at the top of the remote control light when pressing a button to show which mode the remote control is in.

Fitting the batteries

Before using the remote control you need to insert the two AAA cells supplied with the C25.

- Open the cover on the back of the remote control by pressing the back cover gently near the centre of the remote control, and sliding it towards the edge of the remote control.
- Insert the two batteries, with the polarity as indicated on the bottom of the battery compartment.
- Replace the cover and push until it clips into place.



Note: Replace only with 1.5V alkaline cells type AAA or equivalent.

When disposing of old batteries please be considerate to the environment.

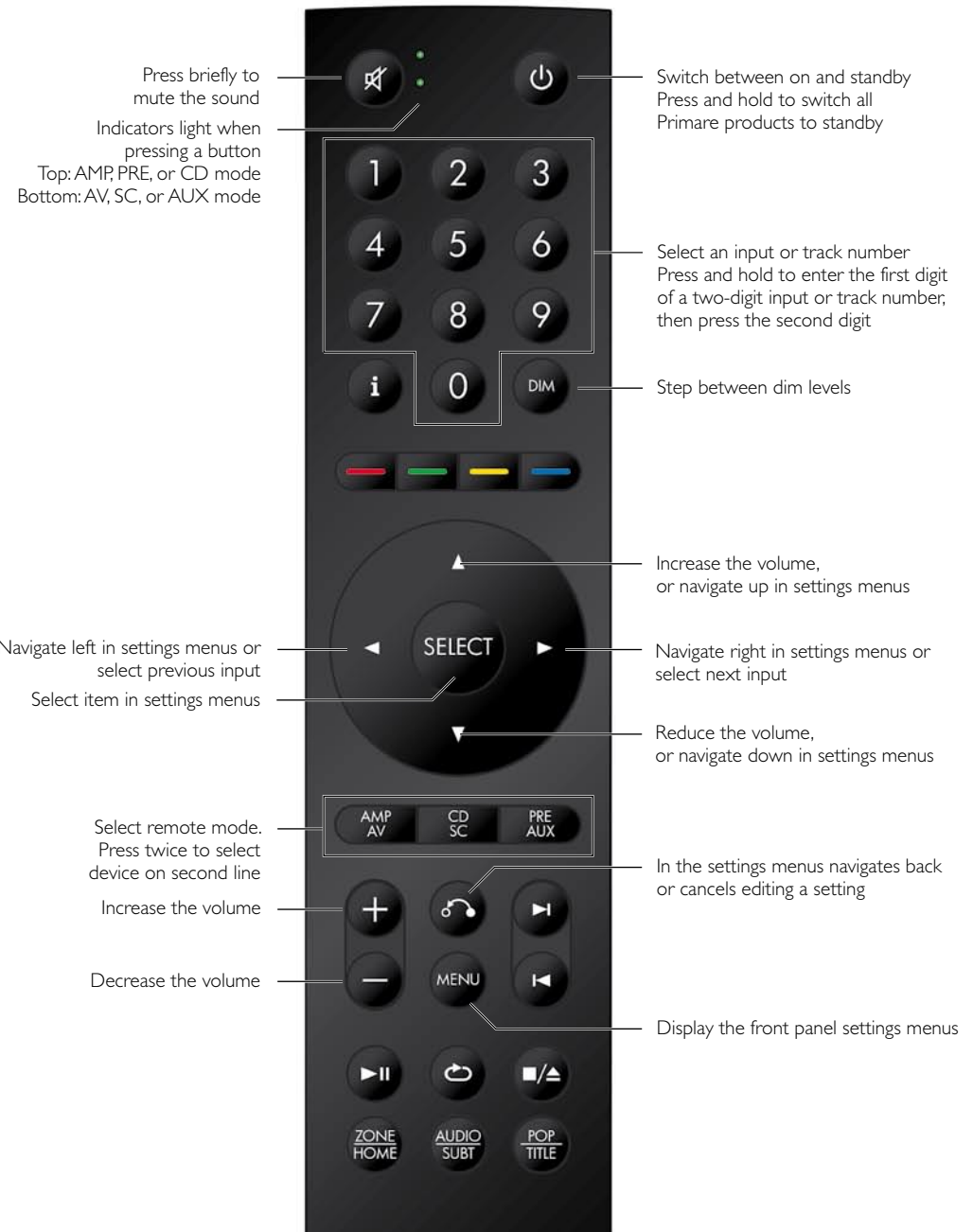

USING THE I25

Front panel controls

Standby

Switches the I25 to standby, or switches it on from standby.

▲ and ▼

Step between inputs.

Settings menus

Pressing ▲ and ▼ simultaneously displays the settings menus or exits from the menus.

In the settings menus:

Pressing ▲ or ▼ steps between the settings.

Holding down ▲ selects a setting or saves an edited setting.

Holding down ▼ navigates back or cancels editing a setting.

Volume

Changes the volume.

Changing the volume

The I25 allows you to vary the volume from 0 (silence) to 99 (maximum).

To change the volume

- Rotate the **VOLUME** control on the front panel, or press the + or – buttons or the ▲ or ▼ buttons on the remote control.

The current volume setting is shown on the front panel; for example:



VOL 28

Selecting a source

The I25 provides a choice of 12 inputs. Initially these are labelled as shown in the following table, but you can give them your own aliases to suit the sources in your system; see *ALIAS*, page 14.

Label	Description
A1–A5	Analogue on RCA connectors.
D6–D9	Digital optical on TOS connectors.
D10, D11	Digital coax on RCA connectors.
PC/MAC (12)	Digital on USB-B connector.

To select a source

- Press the ▲ or ▼ buttons until the source is indicated on the front panel display; for example:

A1
- Alternatively, press the ◀ or ▶ buttons on the remote control to step between sources, or press one of the buttons **1** to **12** on the remote control to select the corresponding source directly.

Changing the display brightness

To change the front panel display brightness

- Press the **DIM** button on the remote control to step through the three levels of illumination and blank.

If you turn the display off it will be restored briefly when you operate any control.

The display automatically dims after ten minutes; you can adjust this delay in the settings menus; see *GENERAL SETTINGS*, page 13.

CONNECTING SOURCES

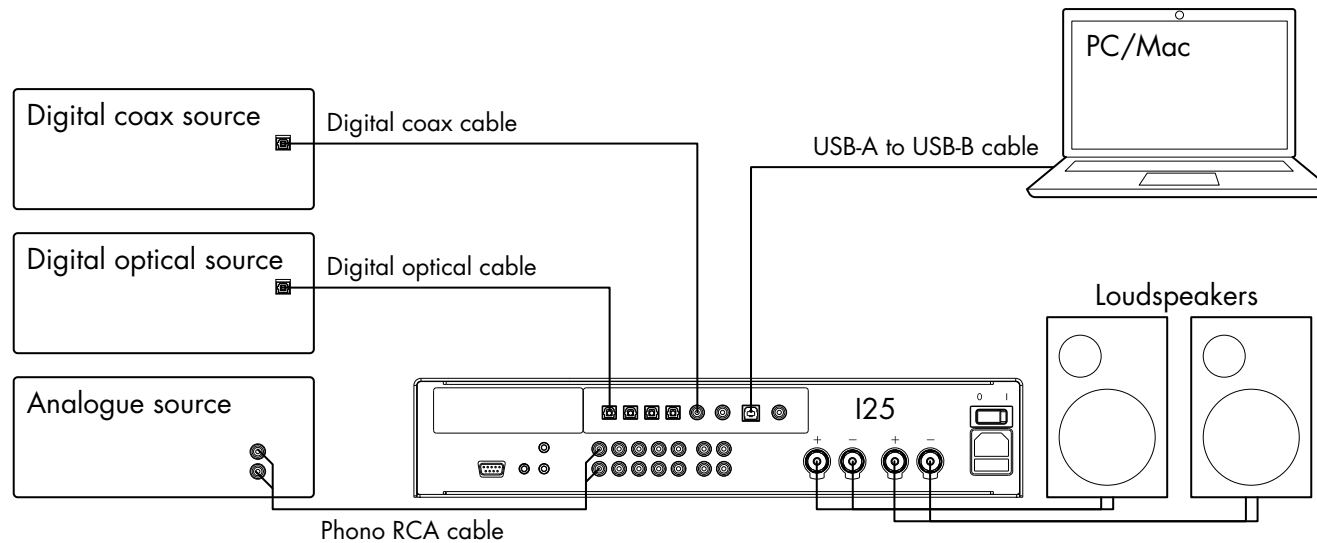

To play music from a source

- Connect the source via a suitable cable:

Analogue	Phono RCA cable
Digital optical source	Digital optical cable
Digital source	Digital coax cable

- Select the source from the front panel, or using the remote control.

To use the I25 as a PC/Mac sound output device

- Connect the Mac or PC to the I25 via a USB-A to USB-B cable.

PC

Windows 7, 8, 8.1, or 10 (32/64-bit) is required. You need to install the Primare xmos audio driver, available on primare.net.

Macintosh

OSX 10.4 or later is recommended. No driver is required.

- Connect the computer's USB port to the USB B input on the I25 using a USB A to USB B cable.

The I25 will then appear as a sound output device called **Primare USB Audio DAC** in the Sound control panel (PC) or Sound system preferences panel (Macintosh).

- Select the PC/MAC source on the I25.
- Select the **Primare USB Audio DAC** as the sound output device in the Mac Sound system preferences panel or the PC Sound control panel.

CONFIGURING THE SETTINGS

Using the settings menus

You can view and change the I25 settings from the front panel or remote control.

To display the settings menu

- Simultaneously press the ▲ and ▼ buttons on the front panel, or press the **MENU** button on the remote control.

The settings menu is displayed:



To step between settings

- Press the ▲ or ▼ buttons on the front panel or remote control.

The current setting is shown highlighted.

To change a setting

- Hold down the ▲ button on the front panel, or press the **SELECT** button on the remote control.

The current value is shown highlighted.

- Press the ▲ or ▼ buttons on the front panel or remote control to change the value of the setting.

As you change it the new value is shown in the menu.

- Hold down the ▲ button on the front panel, or press the **SELECT** button on the remote control, to save the value you have set.

To navigate back or cancel editing a setting

- Hold down the ▼ button on the front panel, or press the ⏪ button on the remote control.

To exit from the settings menu

- Simultaneously press the ▲ and ▼ buttons on the front panel, or press the **MENU** button on the remote control.

INPUT SETTINGS

The **INPUT SETTINGS** menu allows you to customise the inputs to suit the sources in your system:



INPUT

Initially the **INPUT SETTINGS** shows the settings for the currently selected input. Alternatively the **INPUT** option allows you to step between all the inputs. The subsequent options will change according to the input.

ALIAS

Allows you to give the source a name; eg **RADIO**.

- Highlight the **ALIAS** item then hold down the ▲ button on the front panel, or press the **SELECT** button on the remote control.

The **RENAME INPUT** menu is displayed:

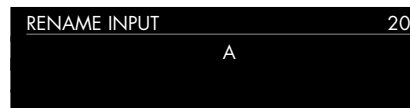

- Press the ▲ or ▼ buttons on the front panel, or the ◀ or ▶ buttons on the remote control, to select the first letter.
- Hold down the ▲ button on the front panel, or press the **SELECT** button on the remote control, to select it.

After adding each character you have the options:

ADD NEW CHARACTER
CONFIRM 'A'
CLEAR ALIAS

where **CONFIRM** shows the alias you have entered so far.

- Select **ADD NEW CHARACTER** to add the remaining letters, up to a maximum of six characters.
- Select **CONFIRM** when you have entered the alias you want.

STATUS

Choose between **ENABLED** (default) or **DISABLED** to specify whether the input is enabled.

AUTO SENSE

Choose between: **SELECT** to automatically select an input containing an audio signal if the I25 is on; **WAKE+SELECT** to automatically wake up the I25 from standby, if necessary, and select an input containing an audio signal; and **OFF** (default) to disable automatic switching.

VOLUME

Choose between **VARIABLE** (default) or **FIXED** to specify whether the input should have variable or fixed gain.

FIXED is 0dB gain, equivalent to volume setting 66, and will overrule **MAXIMUM VOLUME** in **AUDIO SETTINGS**.

Selecting **FIXED** will show a loud-volume warning. Select **YES** to proceed or **NO** to cancel the fixed gain setting.

Fixed gain functions as an SSP (Surround Sound Pass-through) allowing the I25 to be used as an amplifier in a multi-channel system setup

INPUT GAIN

Choose between: -30dB to -1dB, 0dB (default), or +1dB to +30dB to set the gain for the selected input.

If the gain is set too high on an input clipping may occur, and the message:

DECREASE INPUT GAIN

will be displayed. In this case reduce the gain until the warning message is not displayed.

AUDIO SETTINGS

The **AUDIO SETTINGS** menu allows you to customise the balance and start-up volume, and the maximum and mute volume.

AUDIO SETTINGS	20
BALANCE	00LR00
STARTUP VOLUME	30
MAXIMUM VOLUME	99

BALANCE

Allows you to adjust the balance between 00LR-9 (far left), 00LR00 (centred, default) and -9LR00 (far right).

STARTUP VOLUME

Sets the general startup volume to between 0 and 60. The default is 20.

MAXIMUM VOLUME

Sets the maximum volume limit between 0 and 99. The default is 99.

MUTE VOLUME

Sets the volume when unit is muted. You can choose between 0 (default) and 30.

If the current volume is lower than the specified **MUTE VOLUME**, the volume will be set to 0 when pressing mute.

DIGITAL OUTPUT

Allows you to choose the sample rate for analogue inputs on the digital output as **96kHz** (default) or **48kHz**. For digital inputs the output format is the same as the input.

GENERAL SETTINGS

The **GENERAL SETTINGS** menu allows you to configure the general operation of the I25:

GENERAL SETTINGS	20
FRONT PANEL	UNLOCKED
AUTO-DIM	AFTER 10MIN
LED BRIGHTNESS	

SHOW INPUTS

Choose between **ALL** (default), to show all inputs, or **WITH SIGNAL**, to show only inputs that have a signal.

FRONT PANEL

Choose **LOCKED** to lock the front panel buttons and knobs, or **UNLOCKED** (default) to use them.

To unlock the front panel buttons use the remote control to select this menu, or remove power from the I25 for a few seconds.

AUTO-DIM

Allows you to choose the delay for dimming the display after no user interaction, between: **AFTER 1MIN**, **AFTER 5MIN**, **AFTER 10MIN** (default), or **OFF**.

LED BRIGHTNESS

Displays the **LED BRIGHTNESS** menu to allow you to set the display brightness to between 1 and 5 for each display dimming level:

DIM HIGH (default 3), **DIM MID** (default 2), **DIM LOW** (default 1), or **DIM OFF** (default 1).

STANDBY SETTINGS

Displays the **STANDBY SETTINGS** menu to allow you to specify the standby settings.

STANDBY MODE can be set to **ECO** to reduce the standby consumption to less than 0.5W, but only allows the I25 to wake from the analogue and digital inputs, or **NORMAL** which also allows the I25 to wake from the PC/MAC input.

AUTO-STANDBY automatically switches the I25 to standby if there is no user interaction or audio from the current source for a specified delay: **AFTER 10MIN**, **AFTER 15MIN**, **AFTER 20MIN** (default), or **OFF**.

FACTORY RESET

Resets the I25 to the factory default settings.

You are prompted to confirm. Select **YES** to proceed or **NO** to cancel.

FIRMWARE VERSIONS

Displays the **FIRMWARE VERSIONS** menu to allow you to view the versions of firmware installed.

TECHNICAL SPECIFICATION

Speaker outputs

Power

2 x 100W into 8Ω, 2 x 200W into 4Ω

Analogue inputs

5 x RCA, 15kΩ impedance

Analogue outputs

Preamplifier output

1 x RCA, 100Ω impedance

Line output

1 x RCA, 100Ω impedance

Digital inputs

4 x Optical/TOSLINK 192kHz/24 bit

2 x RCA 192kHz/24 bit

1 x USB-A up to 192kHz/24 bit; up to DSD128 (5.6MHz)

1 x USB-B up to 768kHz/32 bit; up to DSD256 (11.2MHz)

Digital output

1 x RCA

Analogue input = selectable between 48 or 96kHz

Digital input = native output

Performance

Gain

Preamplifier output: 16.5dB

Line output: 0dB

Speaker output: 42.5dB

Analogue frequency response

20Hz – 20kHz: -0.2dB

Distortion

THD + N: < 0.05%, 20Hz – 20kHz, 10W at 8Ω

Signal to noise

>100dB (AES17 filter)

General

Control

C25 system remote control

RS232

IR in/out

Trigger out

Power Consumption

Standby (ECO): <0.5W

Standby (NORMAL): <5.5W

Operating: <32W

Dimensions

430 x 420 x 106 mm (w x d x h) with knobs and connectors

430 x 382 x 106 mm (w x d x h) without knobs and connectors

Weight

11 kg

Colour

Black or titanium

ADDITIONAL INFORMATION

These instructions help you get the best possible sound from your I25.

Phase

The phase of the AC supply can make a significant difference to the sound.

Use the Polarity Pen supplied with the I25 to verify which pin is live on your AC power cable.

Ensure that the live pin of the AC power cable is connected to the left-hand pin of the power connector, viewed from the back panel:

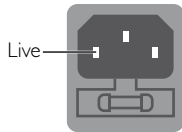

Burn-in

Your Primare will start to sound best after an initial burn-in of approximately 24 hours.

You will notice a further smaller improvement in sound quality for at least another 3 days' playing.

RS232 and trigger

The RS232 input allows you to connect the I25 to a controller system. Use a twisted (null modem) cable. For more information contact Primare at info@primare.net or visit www.primare.net.

The Trigger output allows the I25 to switch on other devices, such as a DD35.

Using the I25 with a DD35

Your I25 is an ideal companion to the Primare DD35 CD Transport. For best results link the two products together as follows using the two cables supplied with the I25:

To connect the trigger cable

The Trigger cable ensures that the DD35 switches on, or to standby, when you operate the ⏻ button on the front panel of the I25.

- Connect the Trigger cable from the I25 TRIG OUT to the DD35 TRIG IN.

Error messages

The following error messages on the front panel display indicate an error condition:

DECREASE INPUT GAIN

Clipping has occurred on an input. Decrease the input gain; see *INPUT GAIN*, page 12.

DC ERROR

Try the following

- Power off I25 and disconnect the speaker connections.

If this solves the problem, check the speaker wiring.

If the problem persists

- Power off I25 and disconnect all input connections.

If this solves the problem, there is a DC offset on one of the inputs.

If the problem persists

- Contact your dealer for service arrangements.

Factory reset

Press and hold the ⏻ standby button on the front panel to display the main firmware version number.

Press and hold the ⏻ standby button on the front panel for 10 seconds to perform a factory reset of the I25.

You can also do a factory reset from the Prisma app, or from the **GENERAL SETTINGS** menu; see *GENERAL SETTINGS*, page 13.

INDEX

A

- Alias (settings menus) 12
- Analogue inputs and outputs 8
- Audio settings menu 13
- Auto-dim (settings menus) 13
- Auto sense (settings menus) 12

B

- Back panel 8
- Balance (settings menus) 13

C

- Clipping 12
- Coax inputs 8

D

- Digital inputs and output 8
- Digital output (settings menus) 13
- Display brightness, changing 10

E

- Error messages 15

F

- Factory reset 15
- Factory reset (settings menus) 13
- Firmware (settings menus) 13
- Front panel (settings menus) 13
- Front panel controls 10

G

- General settings menu 13

I

- Input (settings menus) 12
- Input gain (settings menus) 12
- Inputs, connecting 7
- Input settings menu 12
- IR input 8

L

- LED brightness (settings menus) 13

M

- Maximum volume (settings menus) 13

Menus

- Audio settings 13
- General settings 13
- Input settings 12
- Mute volume (settings menus) 13

N

- Network module 8

O

- Optical inputs 8

P

- PC/Mac sound output device 11
- Phase 15
- Power, connecting 7

R

- Remote control 9
 - Fitting batteries 9
- RS232 input 8, 15

S

- Settings menus 12
- Show inputs (settings menus) 12, 13
- Sources, selecting 10
- Speakers, connecting 7
- Standby settings (settings menus) 13
- Startup volume (settings menus) 13
- Status (settings menus) 12

T

- Technical specification 14
- Trigger outputs 8

U

- Unbalanced inputs and outputs 8

V

- Volume (settings menus) 12
- Volume, changing 10

P R I M A R E

THE SOUND AND VISION OF SCANDINAVIA SINCE 1986

LIMSTENSGATAN 7,
216 16 LIMHAMN, SWEDEN

More information at primare.net

